

Data Sheet



Article number: 021816025500

Description: Clamp with bracket and rubber
SPGU 6025. 500/30 SK

Measures

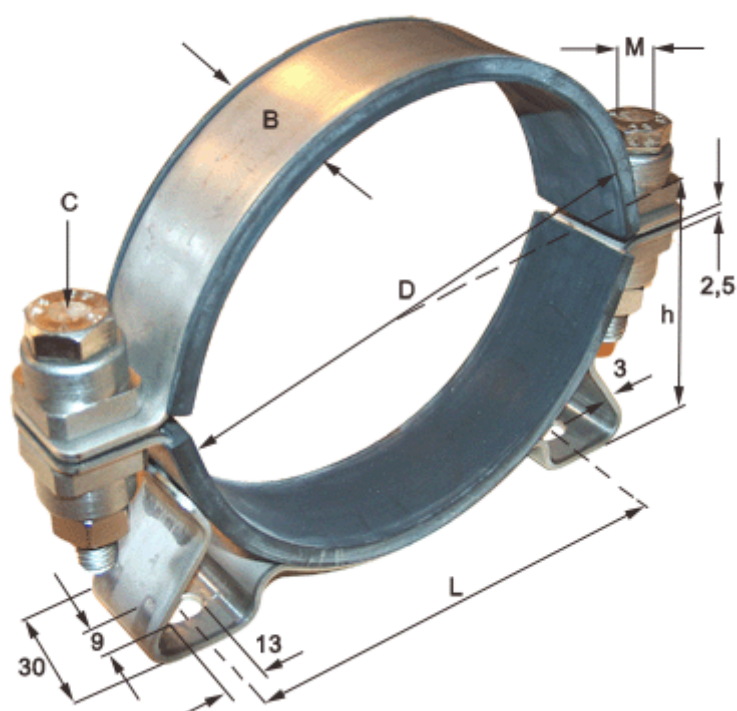

C (screw type) = SK hexagon screw

Diameter D = 500

h = 258

L = 446

Width B = 30